

VR-		
Typ	Di	Da
50x1,5.40	47,3	49,8

Radkörper: Kunststoff

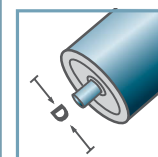

VR-40



D [mm]  
50

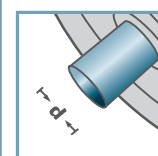

d [mm]  
-

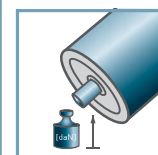

C [daN]  
-

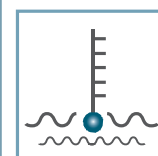

T [°C]  
0° - 80°



Karton [Stck.]

100

# Kunststoffriemenrad

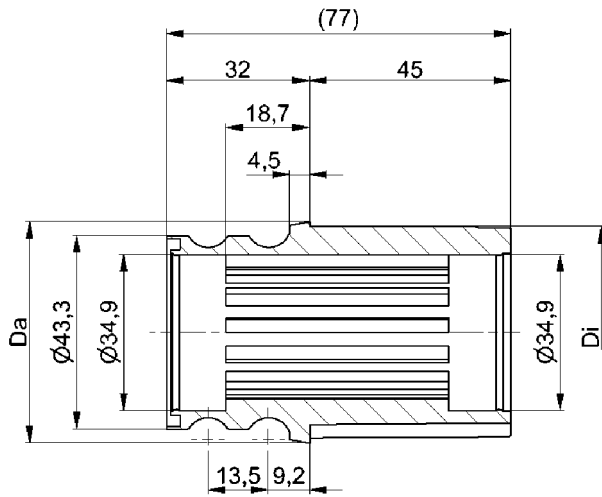

RR-		
Typ	Di	Da
50x1,5.40	47,3	49,8

Radkörper: Kunststoff



RR-40

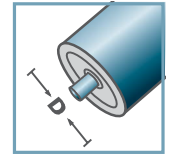

D [mm]  
50

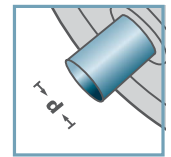

d [mm]  
-



C [daN]  
-

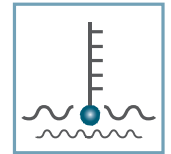

T [°C]  
0° - 80°



Karton [Stck.]

100

# Kunststoffriemenrad

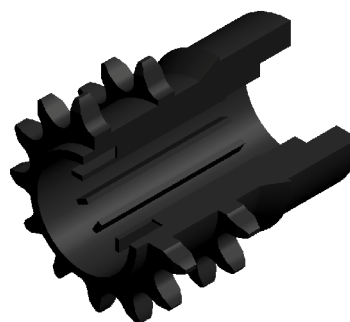
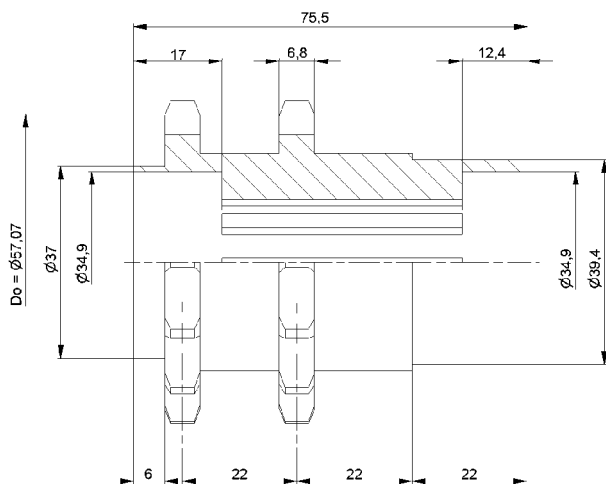

**KKR-1/2"x5/16"-Z14**

Weitere Varianten auf Anfrage!

Radkörper: Kunststoff



KKR-40

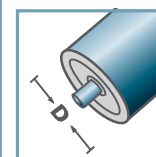

D [mm]

-

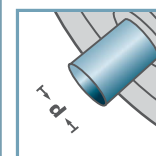

d [mm]

-

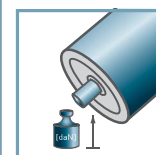

C [daN]

-

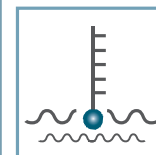

T [°C]

0° - 80°



-



Karton [Stck.]

500

# Kunststoffkettenrad

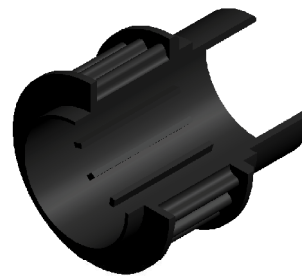
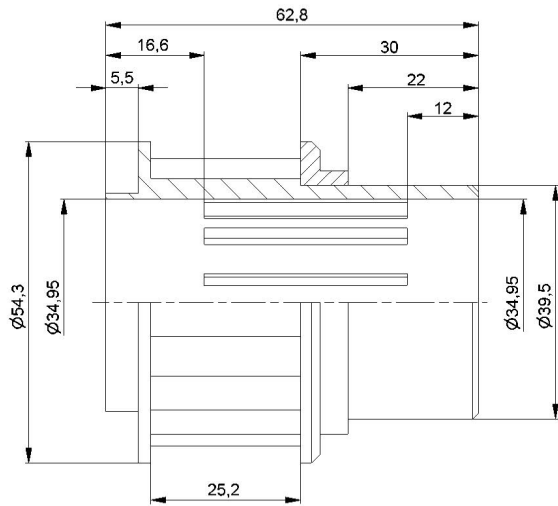

KZA-Z20.40  
 Weitere Varianten auf Anfrage!

Radkörper: Kunststoff



KZA-40

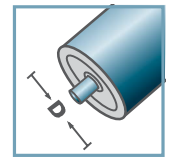

D [mm]

-

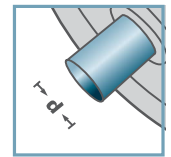

d [mm]

-

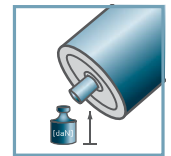

C [daN]

-

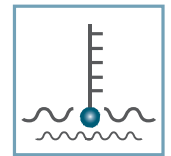

T [°C]

0° - 80°



-



Karton [Stck.]

140

# Kunststoffzahnriemenrad

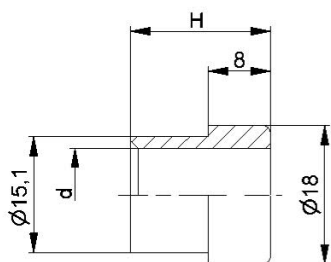

KKR-40		
Typ	d	H
KKR-40	10	19
KKR-40	12	18
KKR-40	14	19
KKR-40	SW11	19

Weitere Varianten auf Anfrage!

Reduzierbuchse: Kunststoff



KKR-40

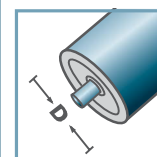

D [mm]

-

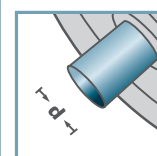

d [mm]

10; 12; 14; SW11

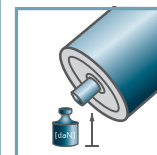

C [daN]

-

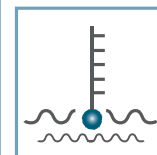

T [°C]

0° - 80°



-



Karton [Stck.]

500/8000

# Zubehör Kettenräder

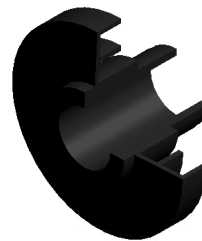
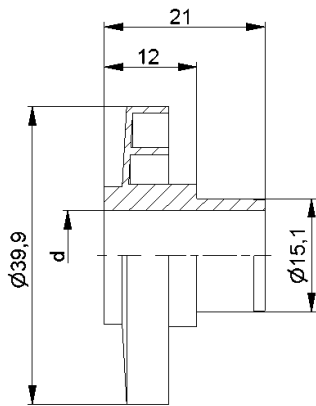

KKR-40	
Typ	d
KKR-40	10
KKR-40	12
KKR-40	14
KKR-40	SW11

Weitere Varianten auf Anfrage!

 Labyrinth: Kunststoff



KKR-40

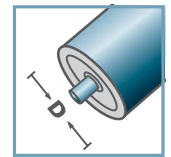

D [mm]

-

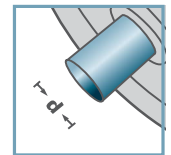

d [mm]

10; 12; 14; SW11



C [daN]

-

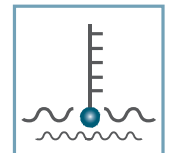

T [°C]

0° - 80°



-



Karton [Stck.]

200/1000

# Zubehör Kettenräder

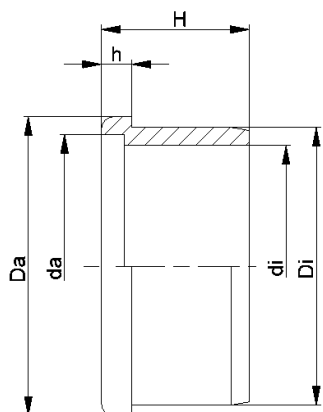

KKR-40						
Typ	Di	Da	di	da	H	h
50x1,5	47,25	50	39,3	42,6	25,2	5
50x2,8	44,7	50	39,3	42,6	25,2	5
60x1,5	57,3	60	47,0	50,7	25,5	5
60x2,0	56,3	60	47,0	50,7	25,5	5

Weitere Varianten auf Anfrage!

☛ Distanzring fest: Kunststoff



KKR-40

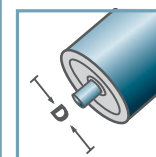

D [mm]  
50 - 60

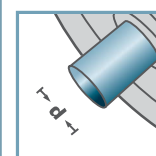

d [mm]  
-

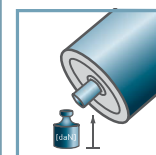

C [daN]  
-

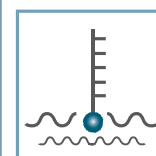

T [°C]  
0° - 80°



-



Karton [Stck.]

ø50: 400  
ø60: 250

# Zubehör Kettenräder



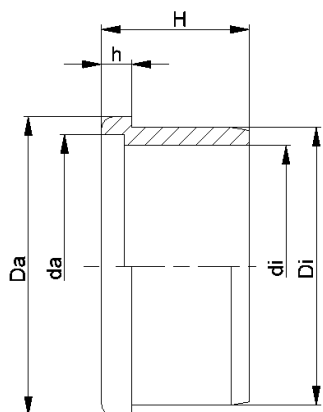

KKR-40						
Typ	Di	Da	di	da	H	h
50x1,5	47,2	50	40,6	44,6	25	5
50x2,8	44,6	50	40,6	44,6	25	5

Weitere Varianten auf Anfrage!

☛ Distanzring für Staubetrieb: Kunststoff



KKR-40

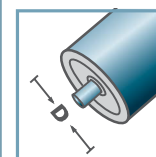

D [mm]  
50 - 60

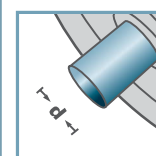

d [mm]  
-

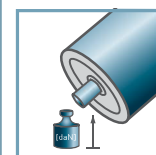

C [daN]  
-

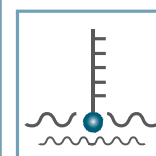

T [°C]  
0° - 80°



-



Karton [Stck.]

400

# Zubehör Kettenräder