

Plastic roller bearings KTR up to 10 daN

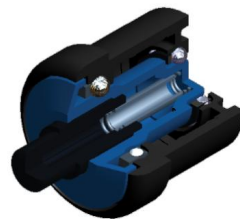

KTR

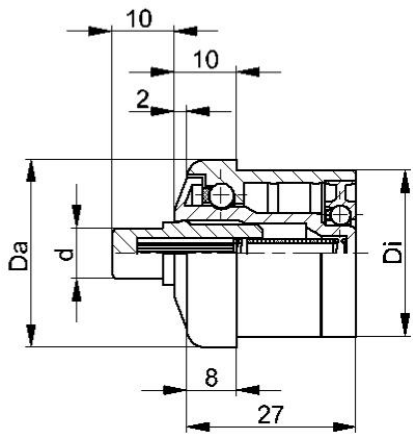

KTR-.00 FA
KTR-.01 FA

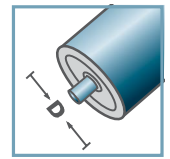

D [mm]
20, 30, 40, 50

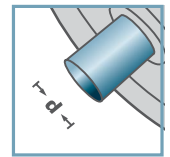

d [mm]
6; 8; 10



C [daN]
8 - 20

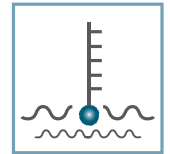

T [°C]
0° - 80°



KTR-.00/.01 FA						
Type	Normal .00	Stainless .01	Di +0,25	Da	d	Load Rating C [daN]
KTR-20x1,5	x	x	17,1	19,9	6	8
KTR-30x1,8	x	x	26,5	29,9	8/10	10
KTR-40x2,3	x	x	35,5	39,9	8/10	10
KTR-50x1,5	x	x	47,3	49,9	8/10	20
KTR-50x2,8	x	x	44,6	49,9	8/10	20

Other dimensions on request!

- ☛ Housing: Plastic
- ☛ Inner Race: Plastic
- ☛ Ball Cage: Plastic
- ☛ Shaft: Plastic
- ☛ Bearing Flange: Plastic
- ☛ Ball, Spring
 - ☛ 00: Steel
 - ☛ 01: 1.4034

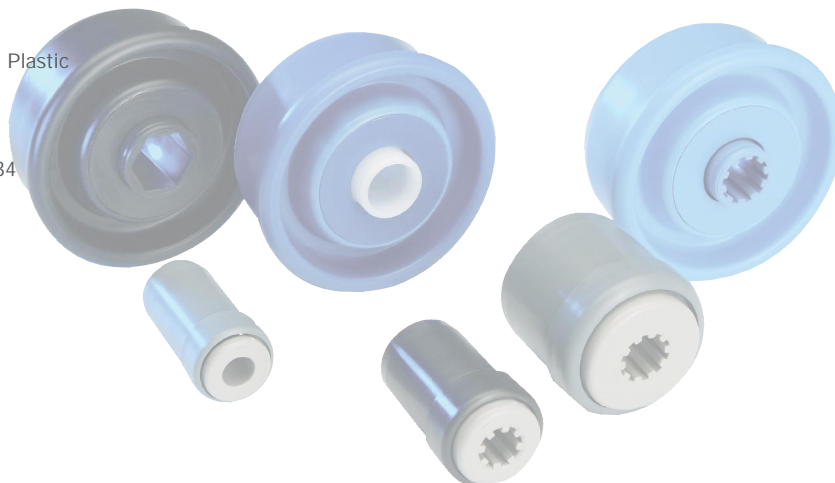

Carton [pcs.]

ø20: 400
ø30: 250/500
ø40: 250/500
ø50: 200

KTR

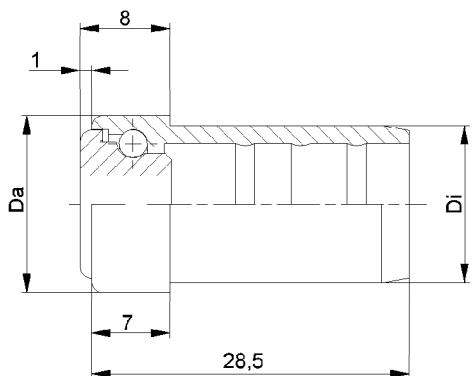

KTR-16.00
KTR-16.01

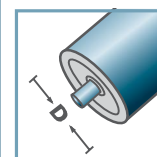

D [mm]
16

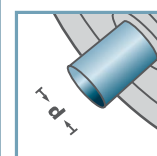

d [mm]
5; 6

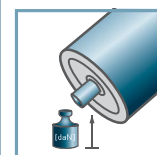

C [daN]
3

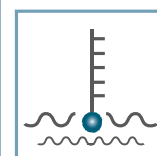

T [°C]
0° - 80°



Carton [pcs.]

500/2500

KTR-16.00/.01					
Type	Normal .00	Stainless .01	Di +0,15	Da	Load Rating C [daN]
KTR-16x1,0	x	x	14,1	15,9	3

Other dimensions on request!

- ☛ Housing: Plastic
- ☛ Inner Race: Plastic
- ☛ Ball
 - ☛ 00: Steel
 - ☛ 01: 1.4034

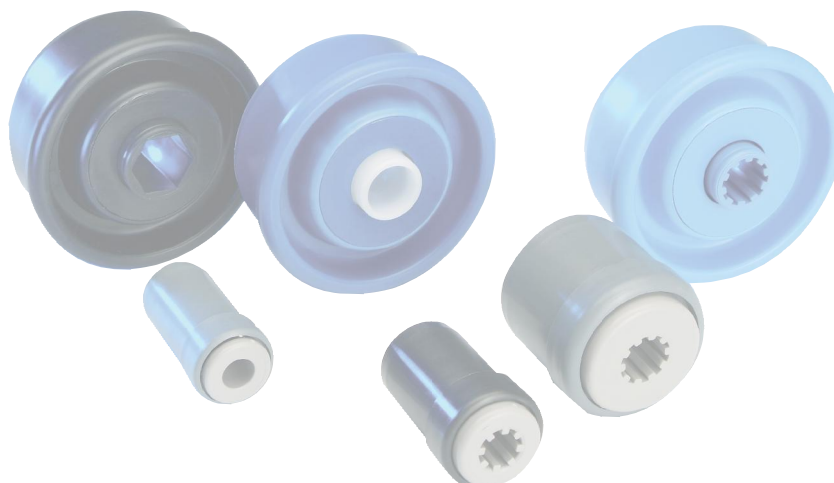

KTR

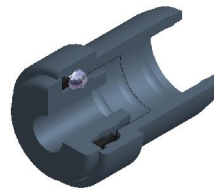
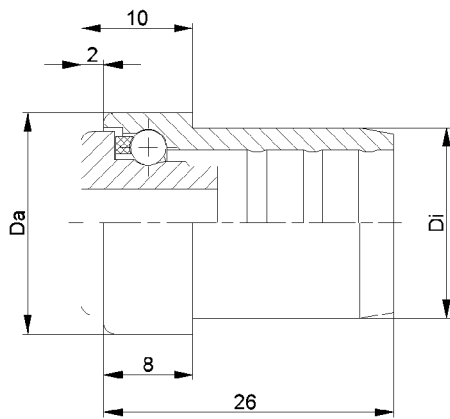

KTR-20.00
KTR-20.01

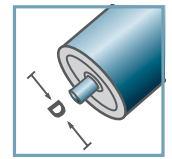

D [mm]
20

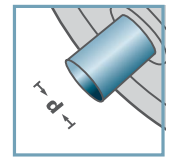

d [mm]
6; 8



C [daN]
5

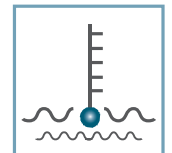

T [°C]
0° - 80°



Carton [pcs.]
500/1000

KTR-20.00/.01					
Type	Normal .00	Stainless .01	Di +0,15	Da	Load Rating C [daN]
KTR-20x1,0	x	x	18,1	19,9	5
KTR-20x1,5	x	x	17,1	19,9	5

Other dimensions on request!

- ☛ Housing: Plastic
- ☛ Inner Race: Plastic
- ☛ Ball Cage: Plastic
- ☛ Ball
 - ☛ 00: Steel
 - ☛ 01: 1.4034

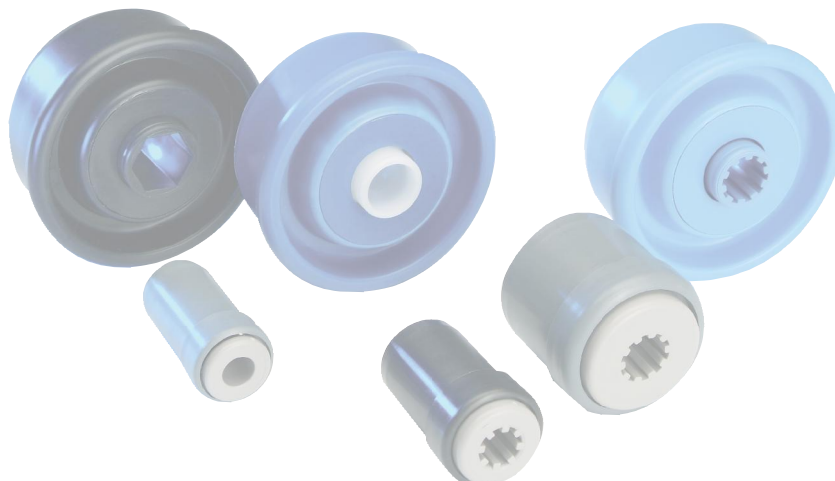

KTR

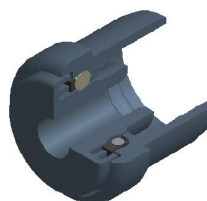
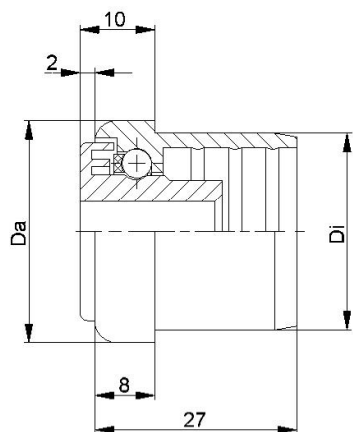

KTR-30.00/.01					
Type	Normal .00	Stainless .01	Di +0,25	Da	Load Rating C [daN]
KTR-30x1,0	x	x	28,1	29,9	7
KTR-30x1,5	x	x	27,1	29,9	7
KTR-30x1,8	x	x	26,5	29,9	7
KTR-30x2,0	x	x	26,35	29,9	7

Other dimensions on request!

- ☛ Housing: Plastic
- ☛ Inner Race: Plastic
- ☛ Ball Cage: Plastic
- ☛ Ball
 - ☛ 00: Steel
 - ☛ 01: 1.4034

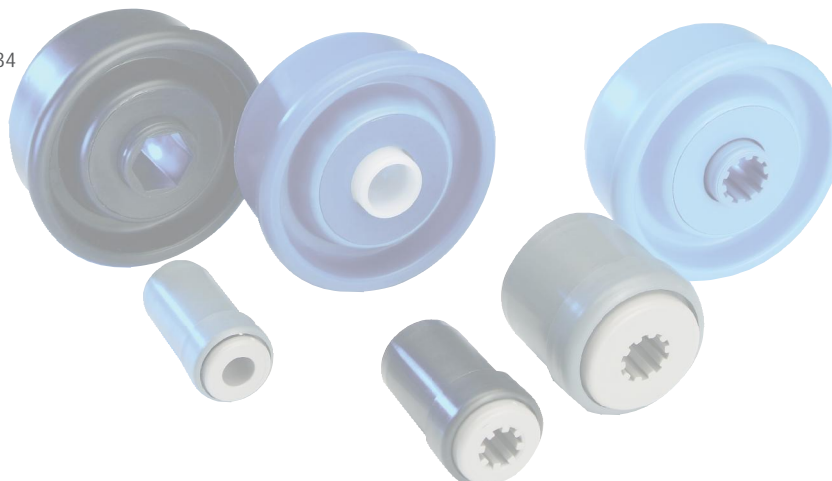

KTR-30.00
KTR-30.01

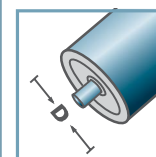

D [mm]
30

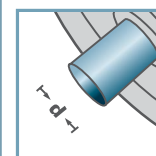

d [mm]
6; 8; 10

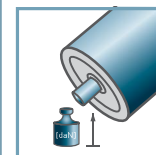

C [daN]
7

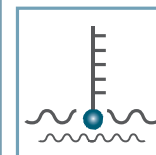

T [°C]
0° - 80°



Carton [pcs.]

250/500

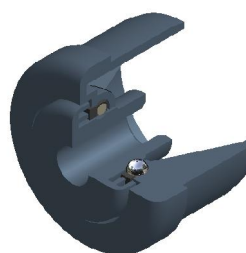
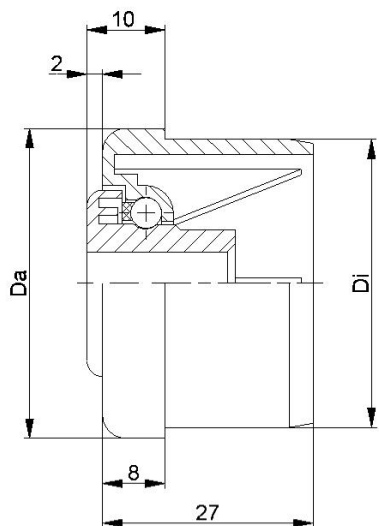

KTR-40.00
KTR-40.01

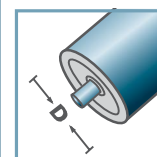

D [mm]
40

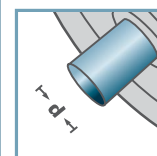

d [mm]
6; 8; 10

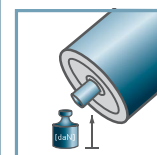

C [daN]
7

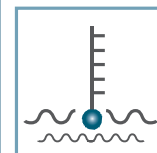

T [°C]
0° - 80°



KTR-40.00/.01					
Type	Normal .00	Stainless .01	Di +0,25	Da	Load Rating C [daN]
KTR-40x1,5	x	x	37,1	39,9	7
KTR-40x2,3	x	x	35,5	39,9	7

Other dimensions on request!

- ☛ Housing: Plastic
- ☛ Inner Race: Plastic
- ☛ Ball Cage: Plastic
- ☛ Ball
 - ☛ 00: Steel
 - ☛ 01: 1.4034

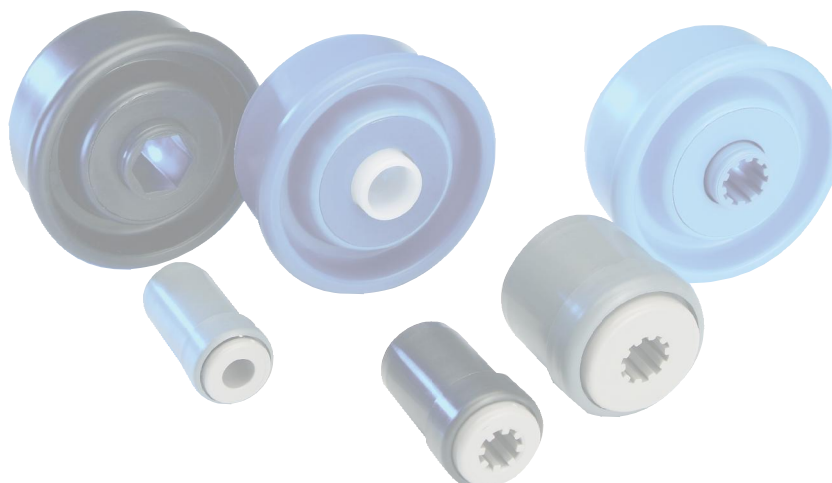

Carton [pcs.]

250

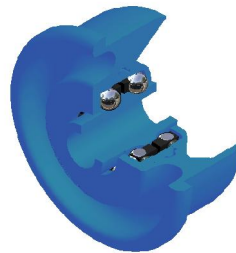
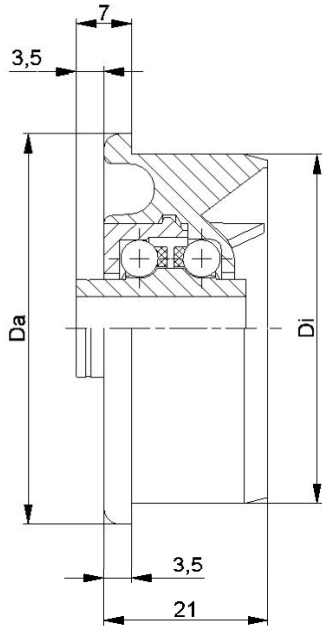

KTR-02
KTR-03

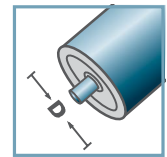

D [mm]
50

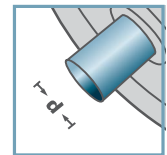

d [mm]
8; 10

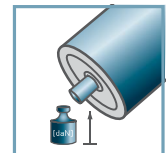

C [daN]
15

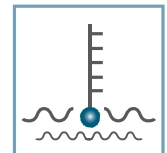

T [°C]
0° - 80°



KTR-02/03					
Type	Normal .02	Stainless .03	Di +0,2	Da	Load Rating C [daN]
KTR-50x1,5	x	x	47,3	49,9	15
KTR-50x2,0	x	x	46,3	49,9	15
KTR-50x2,8	x	x	44,6	49,9	15

Other dimensions on request!

- ☛ Housing: Plastic
- ☛ Inner Race: Plastic
- ☛ Bearing Cap: Plastic
- ☛ Ball Cage: Plastic
- ☛ Ball
 - ☛ 02: Steel
 - ☛ 03: 1.4034

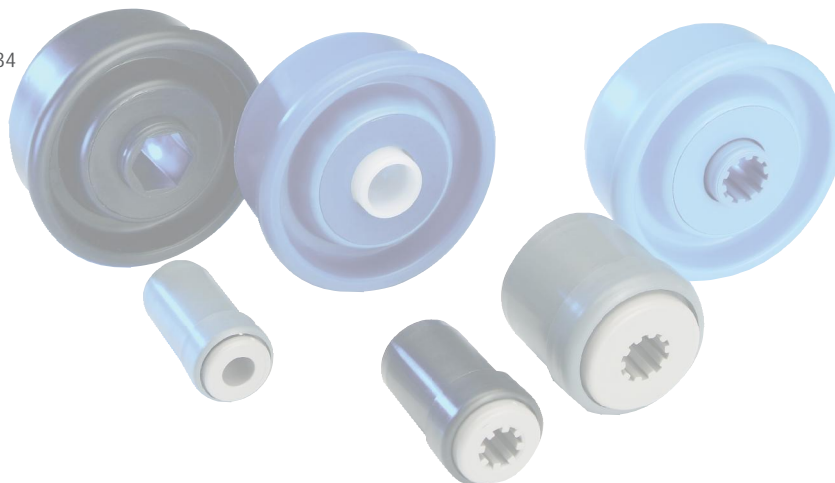

Carton [pcs.]

50x1,5: 250
50x2,0: 250
50x2,8: 250

KTR

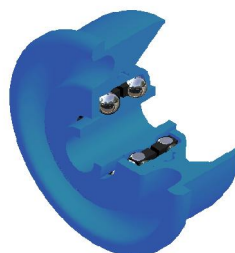
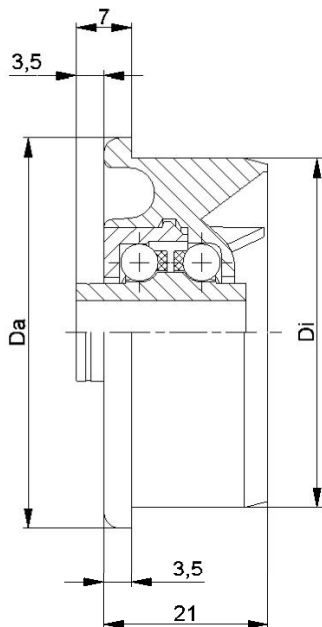

KTR-02/03					
Type	Normal .02	Stainless .03	Di +0,2	Da	Load Rating C [daN]
KTR-50x1,5	x	x	47,3	49,9	10
KTR-50x2,8	x	x	44,6	49,9	10

Other dimensions on request!

- ☛ Housing: Plastic
- ☛ Inner Race: Plastic
- ☛ Bearing Cap: Plastic
- ☛ Ball Cage: Plastic
- ☛ Ball
 - ☛ 02: Steel
 - ☛ 03: 1.4034

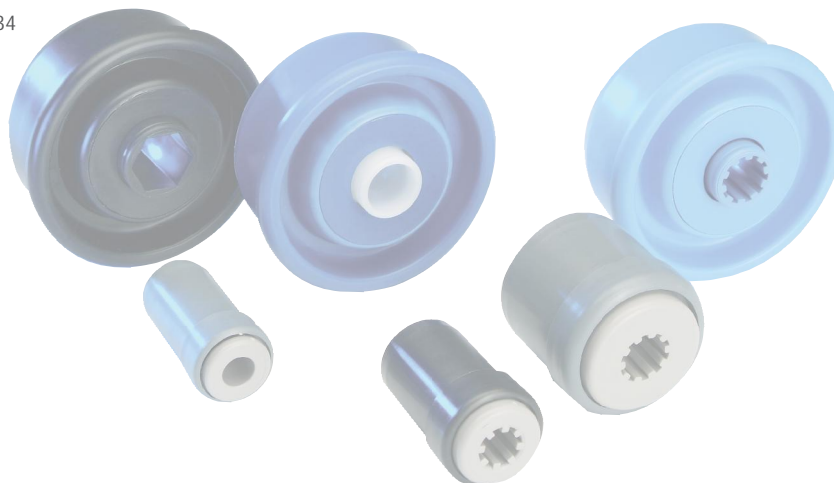

KTR-02
KTR-03

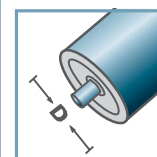

D [mm]
50

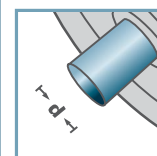

d [mm]
12; SW11

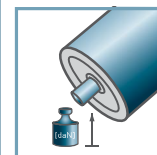

C [daN]
10

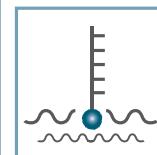

T [°C]
0° - 80°



Carton [pcs.]

250

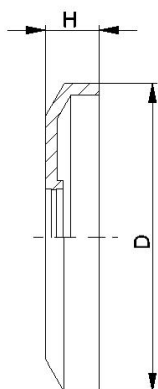

DK-KTR		
Type	D	H
DK-KTR-02	40,5	7

Other dimensions on request!

Seal Bonnet: Plastic

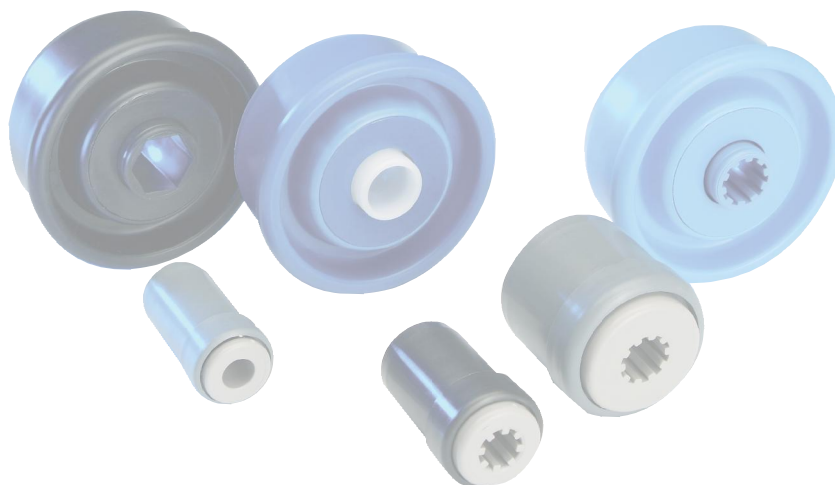

DK-KTR-02

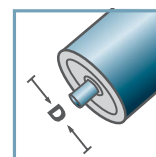

D [mm]

-

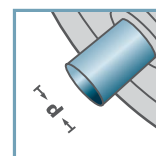

d [mm]

-

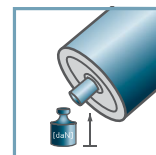

C [daN]

-

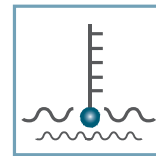

T [°C]

0° - 80°



-



Carton [pcs.]

-

-

-

-

-

-

-

-

-

-

-

-

-

-

-

-

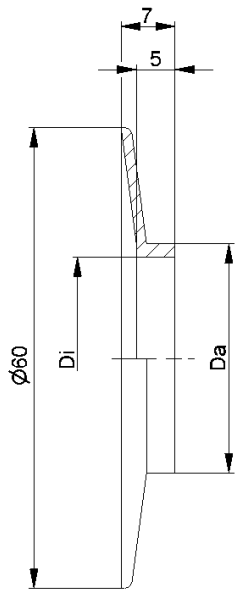

BS-		
Type	Di	Da
BS-30x1,8	26,5	29,9
BS-40x1,5	37,1	39,9
BS-40x2,3	35,5	39,9

Other dimensions on request!

🔩 Wheel Flange: Plastic

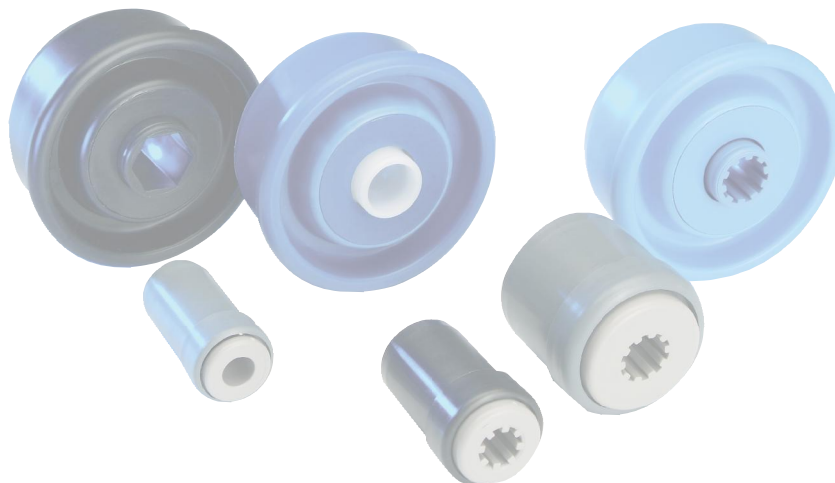

BS-

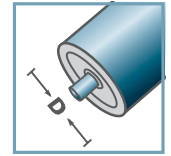

D [mm]
-

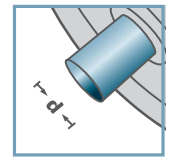

d [mm]
-



C [daN]
-

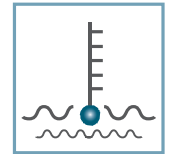

T [°C]
0° - 80°



-



Carton [pcs.]

